

Varenummer: 59GPN10001069

Beskrivelse: KLEE Prop for møtrik GPN 1000 / 1069 - NV 10

Mål

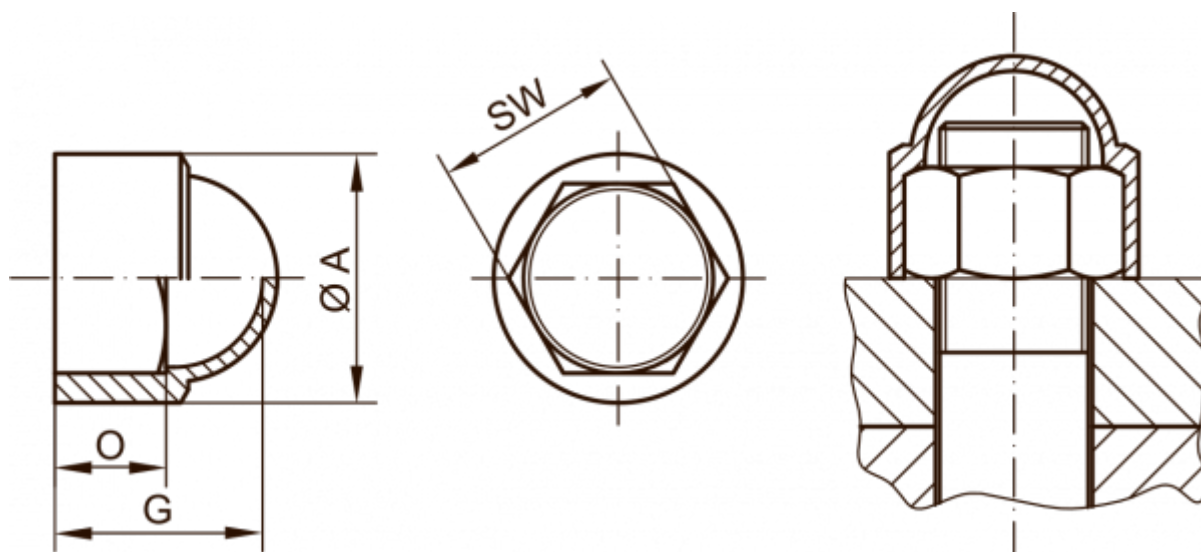

A	= 12.9
For	= M6
G	= 12
O	= 6
SW (Nøglevidde)	= 10